



# IC Test Report

Issued date: Mar. 12, 2024

Project No.: 24Q020503

**Product :** MediaTek Genio 1200 System on Module

**Model :** ESOM-MT-1200

**Series Model :** ESOM-MT-1200 Series, ESOM-MT-1200XXXXXXXXXXXXXXX (“X” can be 0-9, A-Z, - or blank for marketing and customized purpose)

**Applicant :** Vecow Co., Ltd

**Address :** 3F, No. 10, Jiankang Rd., Zhonghe Dist., New Taipei City 23586, Taiwan

**Report No: WD-EI-R-240068-A0**

**According to**

ICES-003: 2020 Issue 7, Class A  
ICES-Gen: 2024 Issue 2

ANSI C63.4: 2014  
ANSI C63.4a: 2017

**Authorized Signatory :**  / Ken Huang

**Wendell Industrial Co., Ltd**  
**Wendell EMC & RF Laboratory**

Add: 5F-1, No. 188, Baoqiao Road, Xindian District, New Taipei City 23145, Taiwan R.O.C.





## Table of Contents

|          |   |           |
|----------|---|-----------|
| <b>1</b> | <b>Certification .....</b>                              | <b>5</b>  |
| 1.1      | Summary of Test Result.....                             | 6         |
| <b>2</b> | <b>Test Configuration of Equipment Under Test .....</b> | <b>7</b>  |
| 2.1      | Test Facility.....                                      | 7         |
| 2.2      | Measurement Uncertainty .....                           | 8         |
| 2.2.1    | Conducted Emission test.....                            | 8         |
| 2.2.2    | Radiated Emission test.....                             | 8         |
| <b>3</b> | <b>General Information.....</b>                         | <b>9</b>  |
| 3.1      | Description of EUT.....                                 | 9         |
| 3.2      | Description of Test Modes.....                          | 10        |
| 3.3      | EUT Operating Condition .....                           | 10        |
| 3.4      | Description of Support Unit .....                       | 11        |
| 3.5      | Configuration of System Under Test.....                 | 12        |
| <b>4</b> | <b>Emission Test.....</b>                               | <b>13</b> |
| 4.1      | Conducted Emission Measurement .....                    | 13        |
| 4.1.1    | Limit of Conducted Emission Measurement .....           | 13        |
| 4.1.2    | Test Instrument .....                                   | 14        |
| 4.1.3    | Test Procedure.....                                     | 15        |
| 4.1.4    | Deviation from Test Standard .....                      | 15        |
| 4.1.5    | Test Setup.....   | 16        |
| 4.1.6    | Test Result .....                                       | 17        |
| 4.1.7    | Photographs of Test Configuration .....                 | 19        |
| 4.2      | Radiated Emission Measurement .....                     | 20        |
| 4.2.1    | Limits of Radiated Emission Measurement .....           | 20        |
| 4.2.2    | Test Instrument .....                                   | 21        |
| 4.2.3    | Test Procedure.....                                     | 22        |
| 4.2.4    | Deviation from Test Standard .....                      | 22        |
| 4.2.5    | Test Setup.....   | 23        |
| 4.2.6    | Test Result .....                                       | 24        |
| 4.2.7    | Photographs of Test Configuration .....                 | 28        |



### History of this test report

| Report No.        | Issue date    | Description   |
|-------------------|---------------|---------------|
| WD-EI-R-240068-A0 | Mar. 12, 2024 | Initial Issue |

#### Declaration

This report is for your exclusive use. Any copying or replication of this report to or for any other person or entity, or use of our name or trademark, is permitted only with our prior written permission. This report sets forth our findings solely with respect to the test samples identified herein. The results set forth in this report are not indicative or representative of the quality or characteristics of the lot from which a test sample was taken or any similar or identical product unless specifically and expressly noted. Our report includes all of the tests requested by you and the results thereof based upon the information that you provided to us.



### History of supplementary report

| Report No.        | Issue date    | Description     |
|-------------------|---------------|-----------------|
| WD-EI-R-240068-A0 | Mar. 12, 2024 | Original report |

#### Declaration

This report is for your exclusive use. Any copying or replication of this report to or for any other person or entity, or use of our name or trademark, is permitted only with our prior written permission. This report sets forth our findings solely with respect to the test samples identified herein. The results set forth in this report are not indicative or representative of the quality or characteristics of the lot from which a test sample was taken or any similar or identical product unless specifically and expressly noted. Our report includes all of the tests requested by you and the results thereof based upon the information that you provided to us.



# 1 Certification

- Product:** MediaTek Genio 1200 System on Module
- Model:** ESOM-MT-1200
- Series Model:** ESOM-MT-1200 Series, ESOM-MT-1200XXXXXXXXXXXXX (“X” can be 0-9, A-Z, - or blank for marketing and customized purpose)
- Applicant:** Vecow Co., Ltd
- Tested:** Feb. 26 ~ Mar. 01, 2024
- Standard:** ICES-003: 2020 Issue 7, Class A  
ICES-Gen: 2024 Issue 2  
ANSI C63.4: 2014  
ANSI C63.4a: 2017

The above equipment (Model: ESOM-MT-1200) has been tested by **Wendell EMC & RF Laboratory**, and found compliance with the requirement of the above standards. The test record, data evaluation and Equipment Under Test (EUT) configurations represented herein are true and accurate accounts of the measurements of the sample’s EMC characteristics under the conditions specified in this report.

Please note that the measurement uncertainty are provided for informational purpose only and are not used in determining the Pass/Fail results.



## 1.1 Summary of Test Result

The EUT has been tested according to the following specifications:

| Emission |  |         |        |                        |
|----------|--|---------|--------|------------------------|
| Standard | Test Item                                | Limit   | Result | Remark                 |
| ICES-003 | Conducted disturbance at mains terminals | Class A | Pass   | Meets the requirements |
|          | Radiated disturbance                     | Class A | Pass   | Meets the requirements |

**Note:** Test record contained in the referenced test report relate only to the EUT sample and test item.



## **2 Test Configuration of Equipment Under Test**

### **2.1 Test Facility**

#### **Conducted disturbance at mains terminals Test**

W01: 5F-1, No.188, Baoqiao Rd., Xindian Dist., New Taipei City 23145, Taiwan (R.O.C)

#### **Conducted disturbance at mains terminals and Radiated emission (9\*6\*6 Chamber) Tests**

W08: No.119, Wugong 3rd Rd., Wugu Dist., New Taipei City 248, Taiwan (R.O.C)

#### **ACCREDITATIONS**

The laboratories are accredited and approved by the TAF according to ISO/IEC 17025.

## 2.2 Measurement Uncertainty

The measurement instrumentation uncertainty is evaluated according to CISPR 16-4-2.

This uncertainty represents an expanded uncertainty expressed at approximately the 95% confidence level using a coverage factor of  $k=2$ .

Wendell EMC & RF Laboratory  $U_{lab}$  is less than  $U_{cispr}$ , therefore compliance or non-compliance with a disturbance limit shall be determined in the following manner.

- compliance is deemed to occur if no measured disturbance level exceeds the disturbance limit;
- non-compliance is deemed to occur if any measured disturbance level exceeds the disturbance limit.

Please note that the measurement uncertainty ( $U_{lab}$ ) is provided for informational purpose only and is not used in determining the Pass/Fail results.

### 2.2.1 Conducted Emission test

| Test Site | Measurement Freq. Range | dB ( $U_{lab}$ ) | Note |
|-----------|-------------------------|------------------|------|
| W01-CE    | 150 kHz ~ 30 MHz        | 2.75             | N/A  |
| W08-CE    | 150 kHz ~ 30 MHz        | 2.76             | N/A  |

### 2.2.2 Radiated Emission test

| Test Site | Measurement Freq. Range | Ant | dB ( $U_{lab}$ ) | Note |
|-----------|-------------------------|-----|------------------|------|
| W08-966-1 | 30 MHz ~ 200 MHz        | V   | 3.78             | N/A  |
|           | 30 MHz ~ 200 MHz        | H   | 2.69             | N/A  |
|           | 200 MHz ~ 1000 MHz      | V   | 4.91             | N/A  |
|           | 200 MHz ~ 1000 MHz      | H   | 3.40             | N/A  |
|           | 1 GHz ~ 6 GHz           | V   | 4.48             | N/A  |
|           | 1 GHz ~ 6 GHz           | H   | 4.33             | N/A  |
|           | 6 GHz ~ 18 GHz          | V   | 4.56             | N/A  |
|           | 6 GHz ~ 18 GHz          | H   | 4.56             | N/A  |
|           | 18 GHz ~ 40 GHz         | V   | 4.42             | N/A  |
|           | 18 GHz ~ 40 GHz         | H   | 4.42             | N/A  |





### 3 General Information

#### 3.1 Description of EUT

|                            |  |
|----------------------------|--|
| <b>Product</b>             | MediaTek Genio 1200 System on Module   |
| <b>Model</b>               | ESOM-MT-1200   |
| <b>Series Model</b>        | ESOM-MT-1200 Series, ESOM-MT-1200XXXXXXXXXXXXXXX (“X” can be 0-9, A-Z, - or blank for marketing and customized purpose)                    |
| <b>Applicant</b>           | Vecow Co., Ltd   |
| <b>Received Date</b>       | Feb. 16, 2024  |
| <b>EUT Power Rating</b>    | 12Vdc (from adapter)   |
| <b>Model Differences</b>   | The models are electrically identical, different models no. are for marketing purpose. The series model information is provided by client. |
| <b>Operating System</b>    | Linux Yocto 3.1  |
| <b>Data Cable Supplied</b> | N/A  |
| <b>Accessory Device</b>    | N/A  |
| <b>I/O Port</b>            | Please refer to the User’s Manual  |

**Note:**

1. The EUT uses the follow adapter:

| <b>Adapter (support unit only)</b> |   |
|------------------------------------|---|
| <b>Brand</b>                       | LITEON  |
| <b>Model</b>                       | HA-1600-12  |
| <b>Input Power</b>                 | 100-240Vac, 1.7A, 50-60Hz   |
| <b>Output Power</b>                | 12Vdc, 5.0A, 60.0W  |
| <b>Power line</b>                  | Input: 1.8m non-shielded cable<br>Output: 1m non-shielded cable with 1 core |

2. The EUT’s highest operating frequency is 2.2GHz. Therefore the radiated emission is tested up to 11GHz.

### 3.2 Description of Test Modes

Test results are presented in the report as below.

| Test Mode                                  | Test Condition |
|--|----------------|
| <b>Conducted emission test</b>             |                |
| -  | Adapter mode   |
| <b>Radiated emission 30MHz ~ 1GHz test</b> |                |
| -  | Adapter mode   |
| <b>Radiated emission above 1GHz test</b>   |                |
| -  | Adapter mode   |

### 3.3 EUT Operating Condition

- Inserted the EUT into the enclosure and placed on test table.
- Prepare PC & NB to act as a communication partner and placed it outside of testing area.
- The EUT was connected to the PC & NB with LAN cable.
- The communication partner sent data to EUT by command "ping" via LAN.
- The EUT run test program "BurnIN.exe" to enable all functions.
- The EUT sent "H" message to monitor and displayed on screen.
- The EUT sent voice signal to earphone.



### 3.4 Description of Support Unit

The EUT has been conducted testing with other necessary accessories or support units.

| Item | Equipment                         | Brand    | Model No.       | Serial No.                           | FCC ID           | Data Cable                            | Power Cable  | Remark             |
|------|-----------------------------------|----------|-----------------|--------------------------------------|------------------|---------------------------------------|--|--------------------|
| 1    | Desktop PC                        | DELL     | D13M            | H6K10 A00                            | FCC DoC Approved | 20m CAT.5E non-shielded RJ45 cable    | 1.8m non-shielded cable  | -                  |
| 2    | Notebook                          | acer     | ZQ0             | NXV9V<br>TA01344718C4<br>B7600       | FCC DoC Approved | 20m CAT.5E non-shielded RJ45 cable    | AC: 1m non-shielded cable<br>DC: 1.4m non-shielded cable with 1 core | -                  |
| 3    | 1080P Monitor                     | DELL     | P2317H          | CN-0PGX4T-Q<br>DC00-7C6-OLE<br>B-A05 | FCC DoC Approved | 1.5m shielded HDMI cable with 2 cores | 1.8m non-shielded cable  | -                  |
| 4    | Keyboard                          | Logitech | Y-U0009         | 1710SC500LA8                         | FCC DoC Approved | 1.5m non-shielded cable               | N/A  | -                  |
| 5    | Mouse                             | Logitech | M-U0026         | HS726HB                              | FCC DoC Approved | 2m non-shielded cable                 | N/A  | -                  |
| 6    | Earphone & Microphone             | E-books  | E-EPA057        | N/A                                  | N/A              | 1.4m non-shielded cable               | N/A  | -                  |
| 7    | MediaTek Genio 1200 Carrier Board | Vecow    | ESOM-MT-1200-CB | N/A                                  | N/A              | N/A                                   | N/A  | Supplied by client |
| 8    | Enclosure                         | N/A      | N/A             | N/A                                  | N/A              | N/A                                   | N/A  | Supplied by client |
| 9    | RS232 terminator                  | N/A      | N/A             | N/A                                  | N/A              | N/A                                   | N/A  | Supplied by client |

- Note:**
1. The core(s) is(are) originally attached to the cable(s).
  2. Item 1-2 acted as communication partners to transfer data.

### 3.5 Configuration of System Under Test

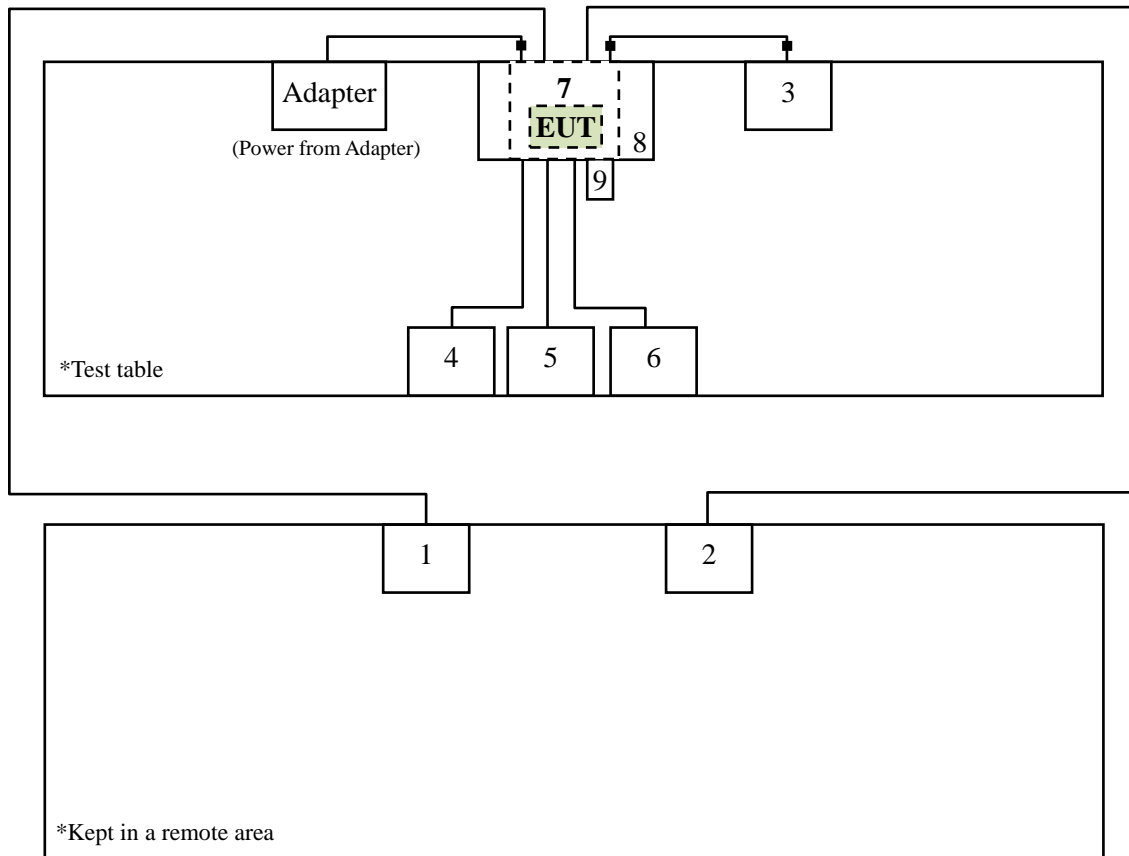



## 4 Emission Test

### 4.1 Conducted Emission Measurement

#### 4.1.1 Limit of Conducted Emission Measurement

| Frequency (MHz) | Class A (dB $\mu$ V)    |                      | Class B (dB $\mu$ V)    |                      |
|-----------------|-------------------------|----------------------|-------------------------|----------------------|
|                 | Quasi-peak (dB $\mu$ V) | Average (dB $\mu$ V) | Quasi-peak (dB $\mu$ V) | Average (dB $\mu$ V) |
| 0.15 - 0.5      | 79                      | 66                   | 66 to 56                | 56 to 46             |
| 0.5 - 5         | 73                      | 60                   | 56                      | 46                   |
| 5 - 30          | 73                      | 60                   | 60                      | 50                   |

- Note:**
1. The lower limit shall apply at the transition frequencies.
  2. The limit decreases in line with the logarithm of the frequency in the range of 0.15 to 0.50 MHz.
  3. Detector function in the form: PK = Peak, QP = Quasi Peak, AV = Average
  4. The test result calculated as following:  
Measurement Value = Reading Level + Correct Factor  
Correction Factor = Insertion loss of LISN + Cable loss + Transient Limiter (If use)  
Margin Level = Measurement Value – Limit Value



#### 4.1.2 Test Instrument

| Test Site: W01-CE |                                |              |                        |            |                        |
|-------------------|--------------------------------|--------------|------------------------|------------|------------------------|
| Item              | Equipment                      | Manufacturer | Model                  | Meter No.  | Calibration Date       |
| 1                 | TWO-LINE V-NETWORK             | R&S          | ENV216                 | CT-1-025-1 | Jun. 09, 2023          |
| 2                 | Pulse limiter                  | R&S          | ESH3-Z2                | CT-2-015   | Jun. 01, 2023          |
| 3                 | EMI Test Receiver              | R&S          | ESCI                   | CT-1-024   | May 30, 2023           |
| 4                 | Artificial Mains Network (AMN) | SCHWARZBECK  | NSLK 8127              | CT-1-104-1 | Jun. 09, 2023          |
| 5                 | RF Cable                       | MVE          | 200200.400LL .500A     | CT-9-101   | Jun. 01, 2023          |
| 6                 | 50ohm Termination              | N/A          | N/A                    | CT-1-065-1 | Jun. 12, 2023          |
| 7                 | Measurement Software           | EZ-EMC       | Ver:<br>EMC-CON<br>3A1 | CT-3-012   | No calibration request |

**Note:** 1. The calibration interval of the above test instruments is 12 months.

| Test Site: W08-CE |                                |                 |                        |               |                        |
|-------------------|--------------------------------|-----------------|------------------------|---------------|------------------------|
| Item              | Equipment                      | Manufacturer    | Model                  | Meter No.     | Calibration Date       |
| 1                 | TWO-LINE V-NETWORK             | R&S             | ENV216                 | CT-1-025-2    | Jun. 16, 2023          |
| 2                 | RF Cable                       | EMCI            | EMCCFD300-BM-BM-5000   | CT-1-107-2    | Jun. 17, 2023          |
| 3                 | EMI Test Receiver              | R&S             | ESR3                   | CT-1-103      | Jun. 19, 2023          |
| 4                 | Artificial Mains Network (AMN) | SCHWARZBECK     | NSLK 8127 RC           | CT-1-104-1R C | Jun. 16, 2023          |
| 5                 | Transient Limiter              | Electro-Metrics | EM-7600                | CT-1-026      | Jun. 17, 2023          |
| 6                 | 50ohm Termination              | N/A             | N/A                    | CT-1-109-1    | Jun. 16, 2023          |
| 7                 | Measurement Software           | EZ-EMC          | Ver:<br>EMC-CON<br>3A1 | CT-3-012      | No calibration request |

**Note:** 1. The calibration interval of the above test instruments is 12 months.



### **4.1.3 Test Procedure**

- a. The table-top EUT was placed 0.8 meter height wooden table from the horizontal ground plane with EUT being connected to power source through a line impedance stabilization network (LISN). The LISN at least be 80 cm from nearest chassis of EUT. The floor-standing EUT and all cables shall be insulated from the ground plane by up to 12 mm of insulating material if required.
- b. The line impedance stabilization network (LISN) provides 50 ohm/50uH of coupling impedance for the measuring instrument. All other support equipments powered from additional LISN(s).
- c. Interrelating cables that hang closer than 40 cm to the ground plane shall be folded back and forth in the center forming a bundle. All I/O cables were positioned to simulate typical usage.
- d. All I/O cables that are not connected to a peripheral shall be bundle in the center. The end of the cable may be terminated, if required, using the correct terminating impedance. The overall length shall not exceed 1 m.
- e. The EMI test receiver connected to LISN powering the EUT. The actual test configuration, please refer to EUT test photos.
- f. The receiver scanned from 150kHz to 30MHz for emissions in each of test modes. A scan was taken on both power lines, Line and Neutral, recording at least six highest emissions.
- g. The EUT and cable configuration of the above highest emission levels were recorded. The test data of the worst case was recorded.

### **4.1.4 Deviation from Test Standard**

No deviation

### 4.1.5 Test Setup

#### < Table-Top equipment >

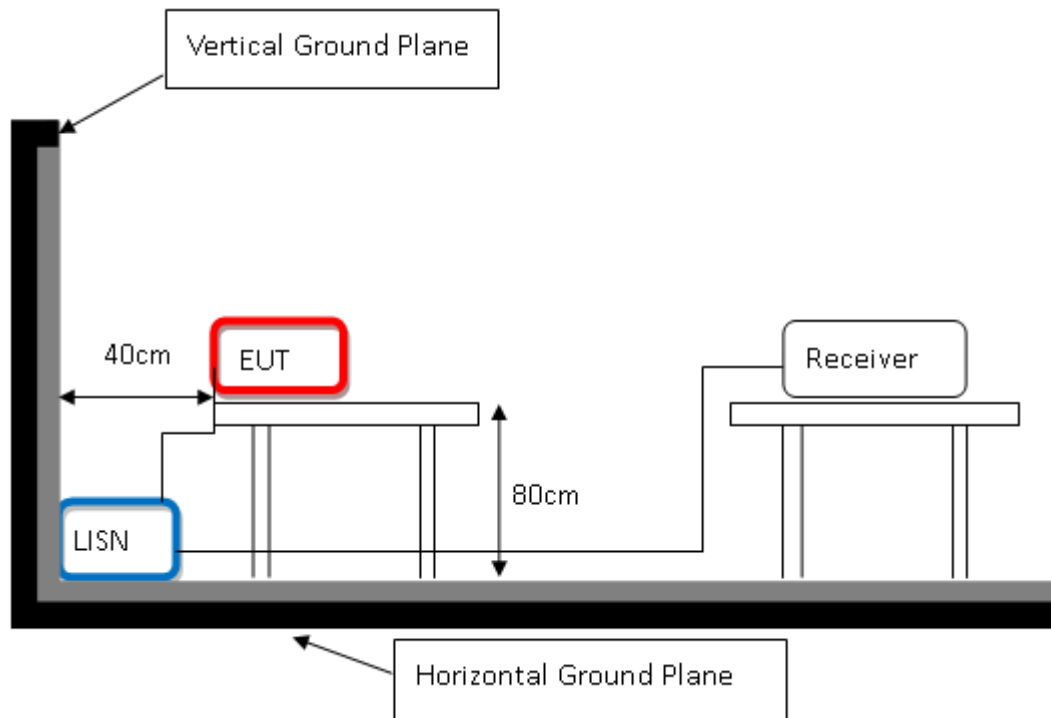

#### < Floor-Standing equipment >

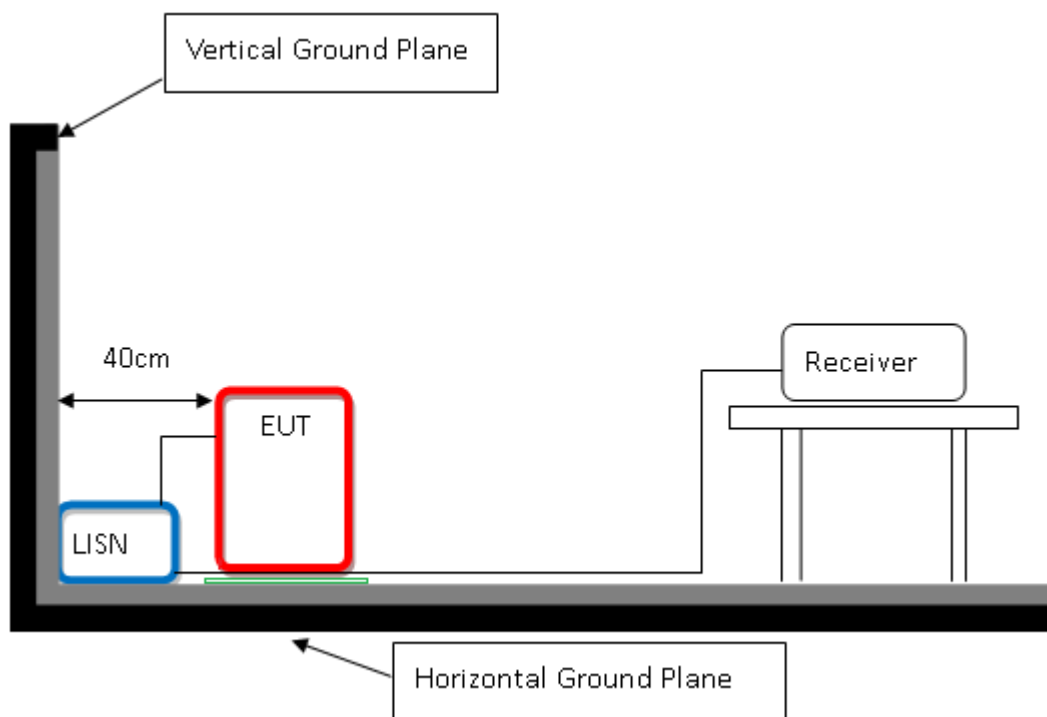

**Note:** Please refer to 4.1.7 for the actual test configuration.





### 4.1.6 Test Result

|                          |              |                 |             |
|--------------------------|--------------|-----------------|-------------|
| Test Voltage             | 120Vac, 60Hz | Frequency Range | 0.15-30 MHz |
| Environmental Conditions | 22°C, 63% RH | 6dB Bandwidth   | 9 kHz       |
| Test Date                | 2024/03/01   | Phase           | L           |
| Tested by                | Guanwei Liao | Test Site       | W01-CE      |

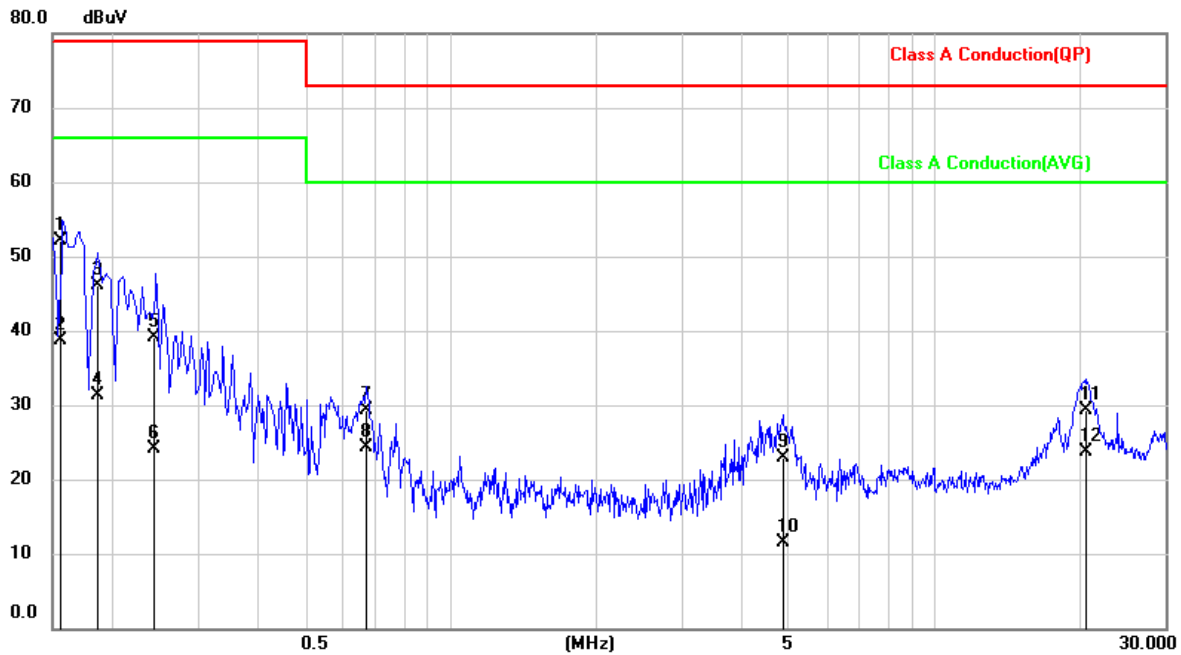

| No. | Frequency (MHz) | Reading Level (dBμV) | Correct Factor (dB) | Measurement (dBμV) | Limit (dBμV) | Margin (dB) | Detector |
|-----|-----------------|----------------------|---------------------|--------------------|--------------|-------------|----------|
| 1   | 0.1548          | 42.19                | 9.95                | 52.14              | 79.00        | -26.86      | QP       |
| 2   | 0.1548          | 28.68                | 9.95                | 38.63              | 66.00        | -27.37      | AVG      |
| 3   | 0.1847          | 36.23                | 9.95                | 46.18              | 79.00        | -32.82      | QP       |
| 4   | 0.1847          | 21.40                | 9.95                | 31.35              | 66.00        | -34.65      | AVG      |
| 5   | 0.2429          | 29.14                | 9.95                | 39.09              | 79.00        | -39.91      | QP       |
| 6   | 0.2429          | 14.06                | 9.95                | 24.01              | 66.00        | -41.99      | AVG      |
| 7   | 0.6726          | 19.43                | 9.95                | 29.38              | 73.00        | -43.62      | QP       |
| 8   | 0.6726          | 14.45                | 9.95                | 24.40              | 60.00        | -35.60      | AVG      |
| 9   | 4.8938          | 12.79                | 10.09               | 22.88              | 73.00        | -50.12      | QP       |
| 10  | 4.8938          | 1.49                 | 10.09               | 11.58              | 60.00        | -48.42      | AVG      |
| 11  | 20.5995         | 19.05                | 10.34               | 29.39              | 73.00        | -43.61      | QP       |
| 12  | 20.5995         | 13.27                | 10.34               | 23.61              | 60.00        | -36.39      | AVG      |

**Remark:** 1. QP = Quasi Peak, AVG = Average  
 2. Correction Factor = Insertion loss of LISN + Cable loss + Transient Limiter (If use)  
 3. Measurement Value = Reading Level + Correct Factor  
 4. Margin Level = Measurement Value - Limit Value



|                                 |              |                        |             |
|---------------------------------|--------------|------------------------|-------------|
| <b>Test Voltage</b>             | 120Vac, 60Hz | <b>Frequency Range</b> | 0.15-30 MHz |
| <b>Environmental Conditions</b> | 22°C, 63% RH | <b>6dB Bandwidth</b>   | 9 kHz       |
| <b>Test Date</b>                | 2024/03/01   | <b>Phase</b>           | N           |
| <b>Tested by</b>                | Guanwei Liao | <b>Test Site</b>       | W01-CE      |

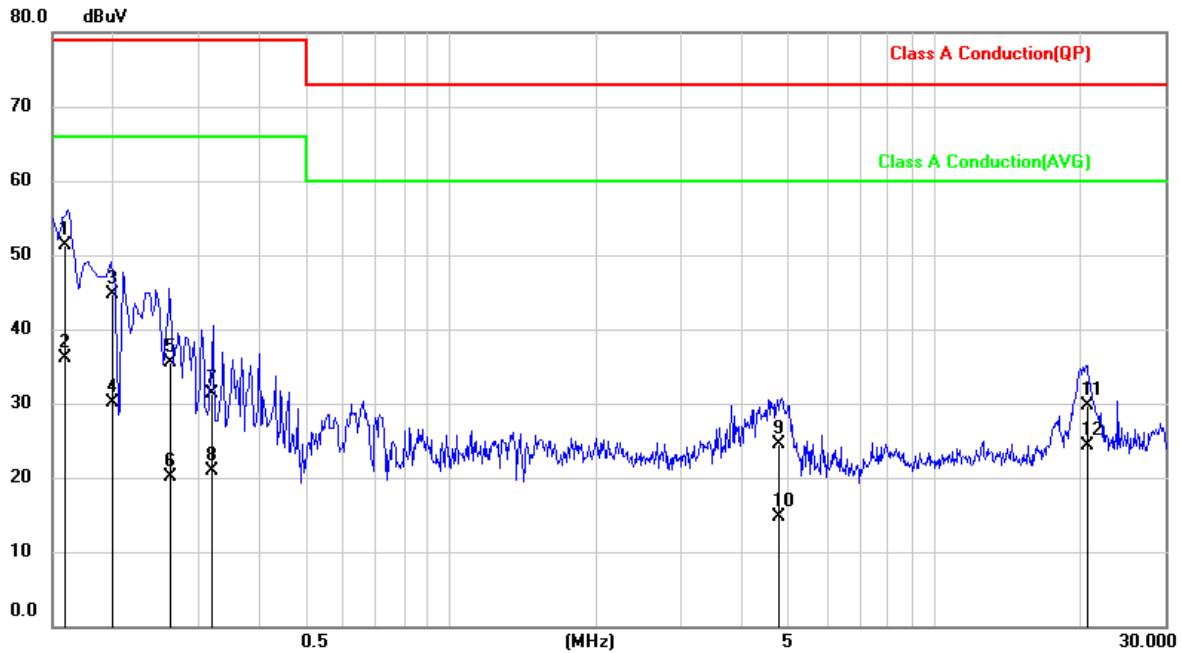

| No. | Frequency (MHz) | Reading Level (dBμV) | Correct Factor (dB) | Measurement (dBμV) | Limit (dBμV) | Margin (dB) | Detector |
|-----|-----------------|----------------------|---------------------|--------------------|--------------|-------------|----------|
| 1   | 0.1587          | 41.31                | 9.97                | 51.28              | 79.00        | -27.72      | QP       |
| 2   | 0.1587          | 26.13                | 9.97                | 36.10              | 66.00        | -29.90      | AVG      |
| 3   | 0.2000          | 34.74                | 9.96                | 44.70              | 79.00        | -34.30      | QP       |
| 4   | 0.2000          | 20.09                | 9.96                | 30.05              | 66.00        | -35.95      | AVG      |
| 5   | 0.2641          | 25.51                | 9.96                | 35.47              | 79.00        | -43.53      | QP       |
| 6   | 0.2641          | 10.16                | 9.96                | 20.12              | 66.00        | -45.88      | AVG      |
| 7   | 0.3193          | 21.39                | 9.97                | 31.36              | 79.00        | -47.64      | QP       |
| 8   | 0.3193          | 10.86                | 9.97                | 20.83              | 66.00        | -45.17      | AVG      |
| 9   | 4.7753          | 14.47                | 10.13               | 24.60              | 73.00        | -48.40      | QP       |
| 10  | 4.7753          | 4.62                 | 10.13               | 14.75              | 60.00        | -45.25      | AVG      |
| 11  | 20.7356         | 19.27                | 10.41               | 29.68              | 73.00        | -43.32      | QP       |
| 12  | 20.7356         | 13.82                | 10.41               | 24.23              | 60.00        | -35.77      | AVG      |

**Remark:** 1. QP = Quasi Peak, AVG = Average  
 2. Correction Factor = Insertion loss of LISN + Cable loss + Transient Limiter (If use)  
 3. Measurement Value = Reading Level + Correct Factor  
 4. Margin Level = Measurement Value - Limit Value

### 4.1.7 Photographs of Test Configuration

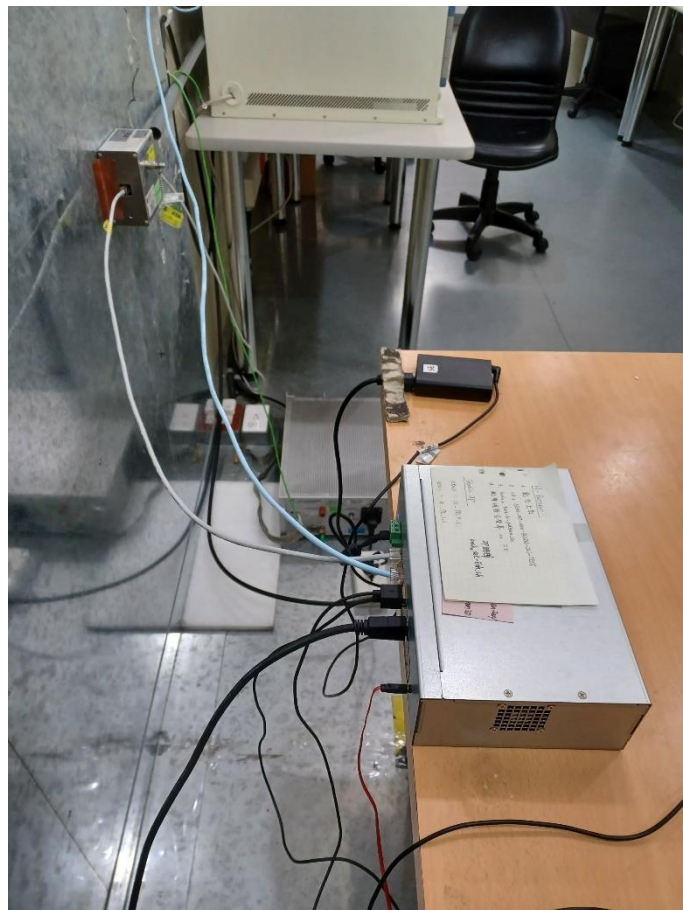
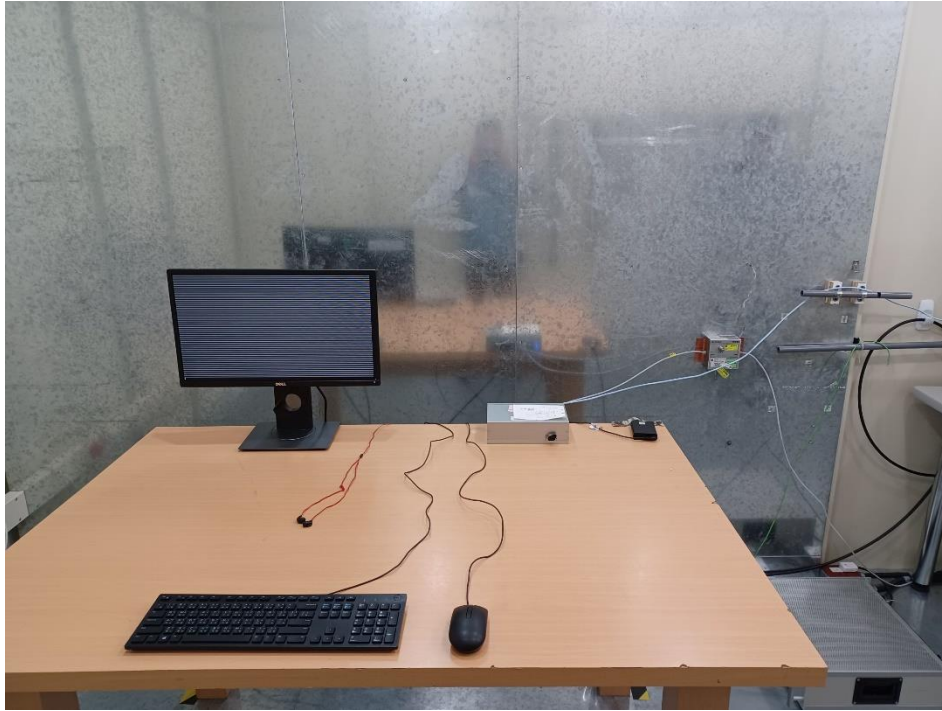



## 4.2 Radiated Emission Measurement

### 4.2.1 Limits of Radiated Emission Measurement

Radiated Frequency range 30 MHz to 1000 MHz

| ICES-003 Radiated Emissions Limits |                                  |                                   |                                  |                                   |
|------------------------------------|----------------------------------|-----------------------------------|----------------------------------|-----------------------------------|
| Frequency range (MHz)              | Class A (3m) Quasi-peak (dBμV/m) | Class A (10m) Quasi-peak (dBμV/m) | Class B (3m) Quasi-peak (dBμV/m) | Class B (10m) Quasi-peak (dBμV/m) |
| 30 - 88                            | 50                               | 40                                | 40                               | 30                                |
| 88 - 216                           | 54                               | 43.5                              | 43.5                             | 33.1                              |
| 216 - 230                          | 56.9                             | 46.4                              | 46                               | 35.6                              |
| 230 - 960                          | 57                               | 47                                | 47                               | 37                                |
| 960 - 1000                         | 60                               | 49.5                              | 54                               | 43.5                              |

Radiated Frequency range above 1 GHz

| ICES-003 Radiated Emissions Limits |                       |         |                       |         |
|------------------------------------|-----------------------|---------|-----------------------|---------|
| Frequency range (GHz)              | Class A (3m) (dBμV/m) |         | Class B (3m) (dBμV/m) |         |
|                                    | Peak                  | Average | Peak                  | Average |
| 1 - 40                             | 80                    | 60      | 74                    | 54      |

**Note:** 1. The lower limit shall apply at the transition frequency.

2. Detector function in the form: PK = Peak, QP = Quasi Peak, AV = Average

3. The test result calculated as following:

Measurement Value = Reading Level + Correct Factor

Correction Factor = Antenna factor + Cable loss (Antenna to preamplifier) - preamplifier Gain + Cable loss (preamplifier to receiver)

Margin Level = Measurement Value - Limit Value

**Frequency Range (For unintentional radiators)**

| Highest frequency generated or used in the device or on which the device operates or tunes (MHz) | Upper frequency of measurement range (MHz)                         |
|--|--|
| 1.705-108  | 1000   |
| 108-500  | 2000   |
| 500-1000   | 5000   |
| Above 1000   | 5th harmonic of the highest frequency or 40GHz, whichever is lower |



## 4.2.2 Test Instrument

| Test Site: W08-966-1 |   |                   |                        |             |                        |
|----------------------|---|-------------------|------------------------|-------------|------------------------|
| Item                 | Equipment                                     | Manufacturer      | Model                  | Meter No.   | Calibration Date       |
| 1                    | Horn Antenna                                  | Schwarzbeck       | BBHA 9120D             | CT-9-031    | Jul. 31, 2023          |
| 2                    | Horn Antenna                                  | Schwarzbeck       | BBHA 9170              | CT-9-032    | Aug. 21, 2023          |
| 3                    | TRILOG Broadband Antenna with 6 dB Attenuator | Schwarzbeck & MVE | VULB 9168 & MVE2251-06 | CT-1-096-1  | May 17, 2023           |
| 4                    | Spectrum Analyzer                             | Agilent           | E4407B                 | CT-1-003(1) | Aug. 02, 2023          |
| 5                    | EXA Signal Analyzer                           | Keysight          | N9010A                 | CT-1-093    | Aug. 18, 2023          |
| 6                    | EMI Test Receiver                             | Keysight          | N9038A                 | CT-9-007    | Aug. 02, 2023          |
| 7                    | Preamplifier                                  | EM                | EM 330                 | CT-9-024    | Aug. 03, 2023          |
| 8                    | Preamplifier                                  | SGH & MCL         | SGH118 & BW-S15W2+     | CT-9-071    | Aug. 03, 2023          |
| 9                    | Preamplifier                                  | EMCI              | EMC184045SE            | CT-9-013    | Aug. 22, 2023          |
| 10                   | Test Cable                                    | EMCI              | EMCCFD400-NM-NM-1000   | CT-1-132    | Aug. 03, 2023          |
| 11                   | Test Cable                                    | PEWC              | CFD400NL-LW-NM-NM-3000 | CT-1-141    | Aug. 03, 2023          |
| 12                   | Test Cable                                    | EMCI              | EMCCFD400-NM-NM-15000  | CT-1-133    | Aug. 03, 2023          |
| 13                   | Test Cable                                    | EMCI              | EMC104-SM-35M-600      | CT-1-134    | Aug. 03, 2023          |
| 14                   | Test Cable                                    | MVE               | 280280.LL266.1400      | CT-9-072    | Aug. 03, 2023          |
| 15                   | Test Cable                                    | EMCI              | EMC102-KM-KM-600       | CT-1-136    | Aug. 22, 2023          |
| 16                   | Measurement Software                          | EZ-EMC            | Ver :WD-03A1-1         | CT-3-012    | No calibration request |

**Note:** 1. The calibration interval of the above test instruments is 12 months.



### 4.2.3 Test Procedure

- a. The table-top EUT was placed on the top of a turntable 0.8 meters above the ground at 3 m 966 chamber. The floor-standing EUT and all cables shall be insulated from the ground plane by up to 12 mm of insulating material if required. The table was rotated 360 degrees to determine the position of the high radiation emissions.
- b. The height of the test antenna shall vary between 1 m to 4 m. Both vertical and horizontal polarizations of the antenna were set to make the measurement.
- c. The EUT was set up as per the test configuration to simulate typical usage per the user's manual. All I/O cables were positioned to simulate typical usage. The actual test configuration, please refer to EUT test photos.
- d. The initial step in collecting radiated emission data is a Spectrum Mode scanning the measurement frequency range.

#### **Below 1GHz:**

Reading in which marked as QP or Peak means measurements by using Spectrum Mode with detector RBW=120kHz.

If the Spectrum Mode measured peak value compliance with and lower than Quasi Peak Limit, the EUT shall be deemed to meet QP Limits.

#### **Above 1GHz:**

Reading in which marked as Peak & AVG means measurements by using Spectrum Mode with setting in RBW=1MHz.

If the Spectrum Mode measured value compliance with the Peak Limits and lower than AVG Limits, the EUT shall be deemed to meet both Peak and AVG Limits.

- e. Emission frequency and amplitude were recorded, recording at least six highest emissions. The EUT and cable configuration of the above highest emission levels were recorded. The test data of the worst case was recorded.

### 4.2.4 Deviation from Test Standard

No deviation

## 4.2.5 Test Setup

< Radiated Emissions Frequency: 30 MHz to 1000 MHz >

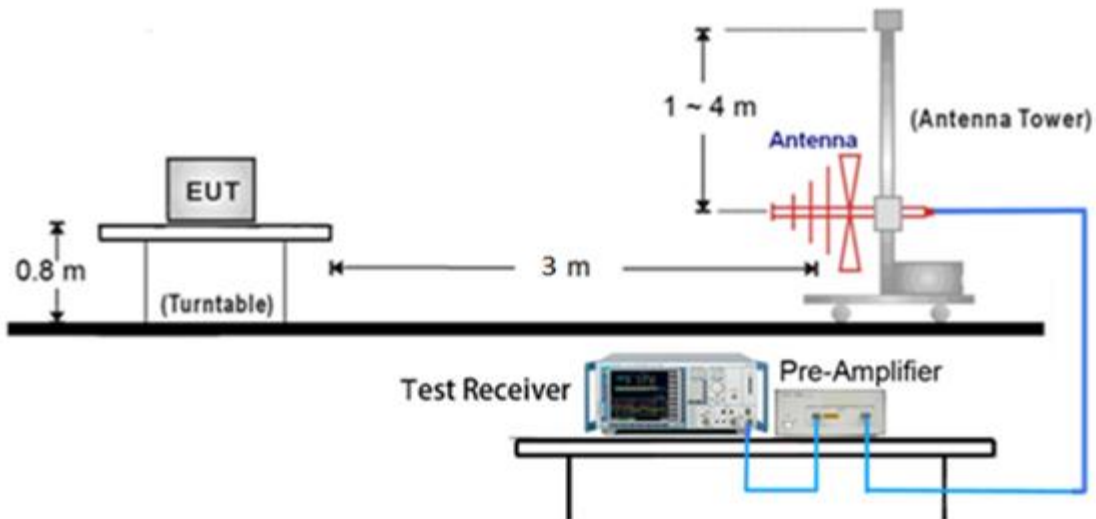

< Radiated Emissions Frequency: above 1GHz >

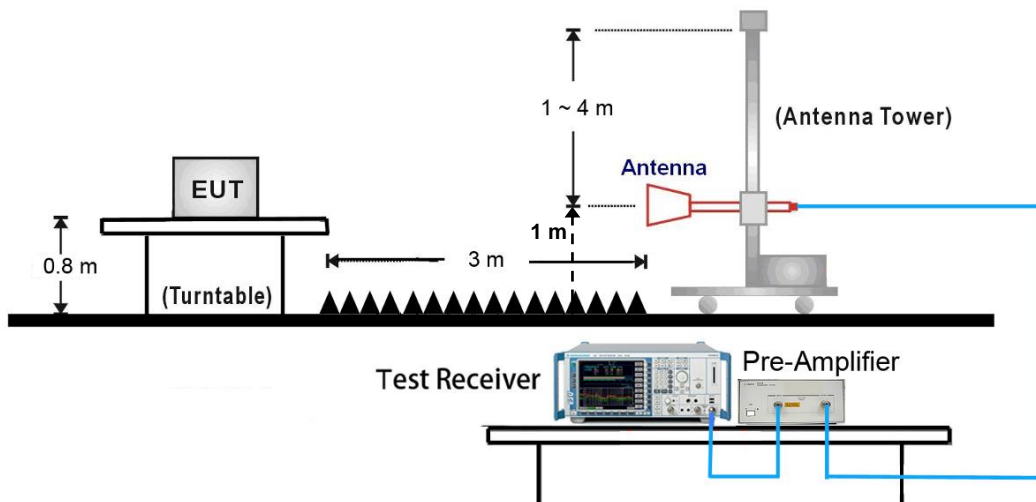

### Note:

- (1) Please refer to the 4.2.7 for the actual test configuration.
- (2) The formula of measured value as:  $\text{Test Result} = \text{Reading} + \text{Correction Factor}$
- (3) Detector function in the form: PK = Peak, QP = Quasi Peak, AV = Average
- (4) The test result calculated as following:  
 $\text{Measurement Value} = \text{Reading Level} + \text{Correct Factor}$   
 $\text{Correct Factor} = \text{Antenna Factor} + \text{Cable Loss} - \text{Amplifier Gain (if use)}$   
 $\text{Margin Level} = \text{Measurement Value} - \text{Limit Value}$



### 4.2.6 Test Result

|                                 |              |                        |               |
|---------------------------------|--------------|------------------------|---------------|
| <b>Test Voltage</b>             | 120Vac, 60Hz | <b>Frequency Range</b> | 30 – 1000 MHz |
| <b>Environmental Conditions</b> | 23°C, 51% RH | <b>6dB Bandwidth</b>   | 120 kHz       |
| <b>Test Date</b>                | 2024/02/26   | <b>Test Distance</b>   | 3m            |
| <b>Tested by</b>                | Karwin Kao   | <b>Polarization</b>    | Vertical      |
| <b>Test Site</b>                | W08-966-1    |                        |               |

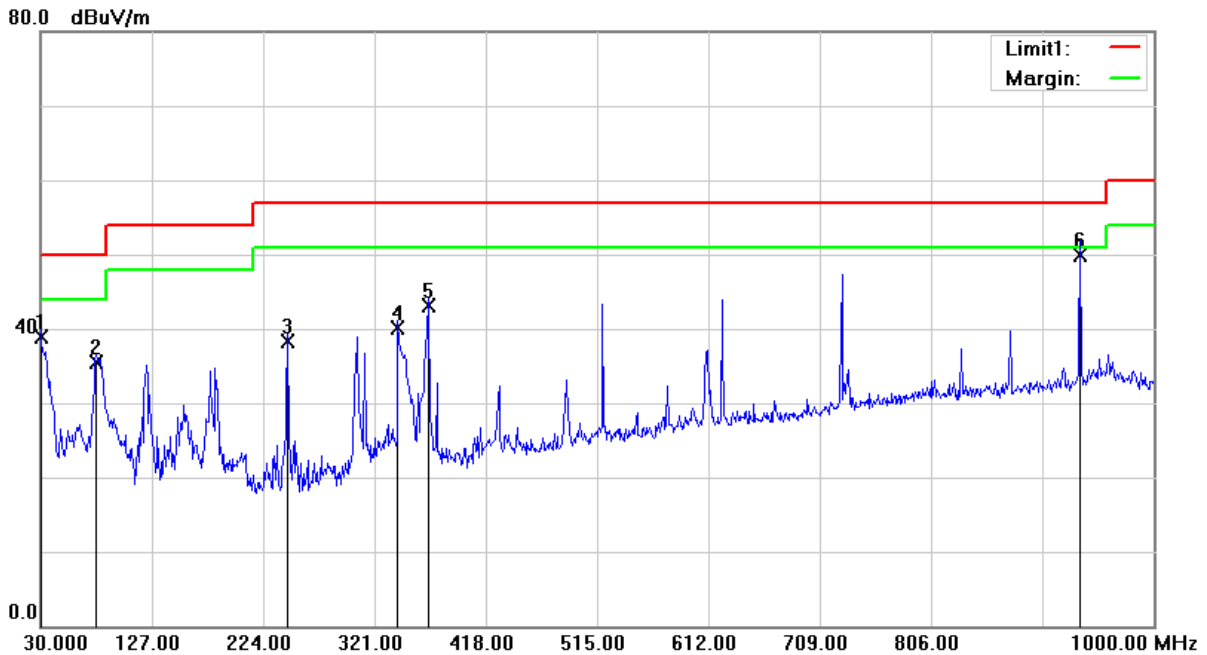

| No. | Frequency (MHz) | Reading Level (dB $\mu$ V) | Correct Factor (dB/m) | Measurement (dB $\mu$ V/m) | Limit (dB $\mu$ V/m) | Margin (dB) | Table Degree (degree) | Antenna Height (cm) | Detector |
|-----|-----------------|----------------------------|-----------------------|----------------------------|----------------------|-------------|-----------------------|---------------------|----------|
| 1   | 30.0000         | 50.58                      | -11.73                | 38.85                      | 50.00                | -11.15      | 0                     | 100                 | QP       |
| 2   | 78.5000         | 50.01                      | -14.46                | 35.55                      | 50.00                | -14.45      | 76                    | 100                 | QP       |
| 3   | 245.3400        | 48.80                      | -10.53                | 38.27                      | 57.00                | -18.73      | 313                   | 200                 | QP       |
| 4   | 341.3700        | 47.45                      | -7.44                 | 40.01                      | 57.00                | -16.99      | 359                   | 200                 | QP       |
| 5   | 367.5600        | 50.02                      | -6.92                 | 43.10                      | 57.00                | -13.90      | 188                   | 100                 | QP       |
| 6   | 935.9800        | 44.45                      | 5.54                  | 49.99                      | 57.00                | -7.01       | 320                   | 100                 | QP       |

**Remark:** 1. QP = Quasi Peak  
 2. Correction Factor = Antenna factor + Cable loss (Antenna to preamplifier) - preamplifier Gain + Cable loss (preamplifier to receiver)  
 3. Measurement Value = Reading Level + Correct Factor  
 4. Margin Level = Measurement Value - Limit Value





|                                 |              |                        |               |
|---------------------------------|--------------|------------------------|---------------|
| <b>Test Voltage</b>             | 120Vac, 60Hz | <b>Frequency Range</b> | 30 – 1000 MHz |
| <b>Environmental Conditions</b> | 23°C, 51% RH | <b>6dB Bandwidth</b>   | 120 kHz       |
| <b>Test Date</b>                | 2024/02/26   | <b>Test Distance</b>   | 3m            |
| <b>Tested by</b>                | Karwin Kao   | <b>Polarization</b>    | Horizontal    |
| <b>Test Site</b>                | W08-966-1    |                        |               |

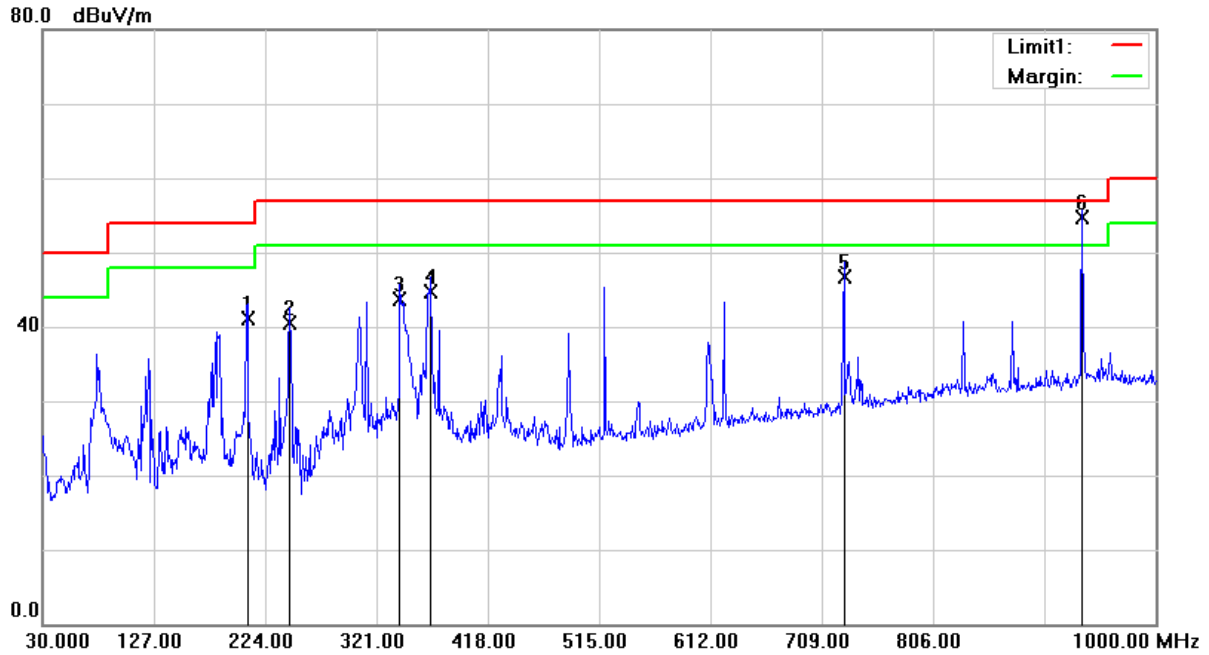

| No. | Frequency (MHz) | Reading Level (dBμV) | Correct Factor (dB/m) | Measurement (dBμV/m) | Limit (dBμV/m) | Margin (dB) | Table Degree (degree) | Antenna Height (cm) | Detector |
|-----|-----------------|----------------------|-----------------------|----------------------|----------------|-------------|-----------------------|---------------------|----------|
| 1   | 208.4800        | 53.66                | -12.62                | 41.04                | 54.00          | -12.96      | 300                   | 200                 | QP       |
| 2   | 245.3400        | 51.04                | -10.53                | 40.51                | 57.00          | -16.49      | 290                   | 100                 | QP       |
| 3   | 341.3700        | 51.07                | -7.44                 | 43.63                | 57.00          | -13.37      | 49                    | 100                 | QP       |
| 4   | 368.5300        | 51.64                | -6.87                 | 44.77                | 57.00          | -12.23      | 76                    | 100                 | QP       |
| 5   | 728.4000        | 44.51                | 2.27                  | 46.78                | 57.00          | -10.22      | 185                   | 200                 | QP       |
| 6   | 935.9800        | 49.26                | 5.54                  | 54.80                | 57.00          | -2.20       | 168                   | 200                 | QP       |

**Remark:** 1. QP = Quasi Peak  
 2. Correction Factor = Antenna factor + Cable loss (Antenna to preamplifier ) - preamplifier Gain + Cable loss (preamplifier to receiver )  
 3. Measurement Value = Reading Level + Correct Factor  
 4. Margin Level = Measurement Value - Limit Value



|                                 |              |                        |           |
|---------------------------------|--------------|------------------------|-----------|
| <b>Test Voltage</b>             | 120Vac, 60Hz | <b>Frequency Range</b> | 1 – 11GHz |
| <b>Environmental Conditions</b> | 23°C, 51% RH | <b>6dB Bandwidth</b>   | 1MHz      |
| <b>Test Date</b>                | 2024/02/26   | <b>Test Distance</b>   | 3m        |
| <b>Tested by</b>                | Karwin Kao   | <b>Polarization</b>    | Vertical  |
| <b>Test Site</b>                | W08-966-1    |                        |           |

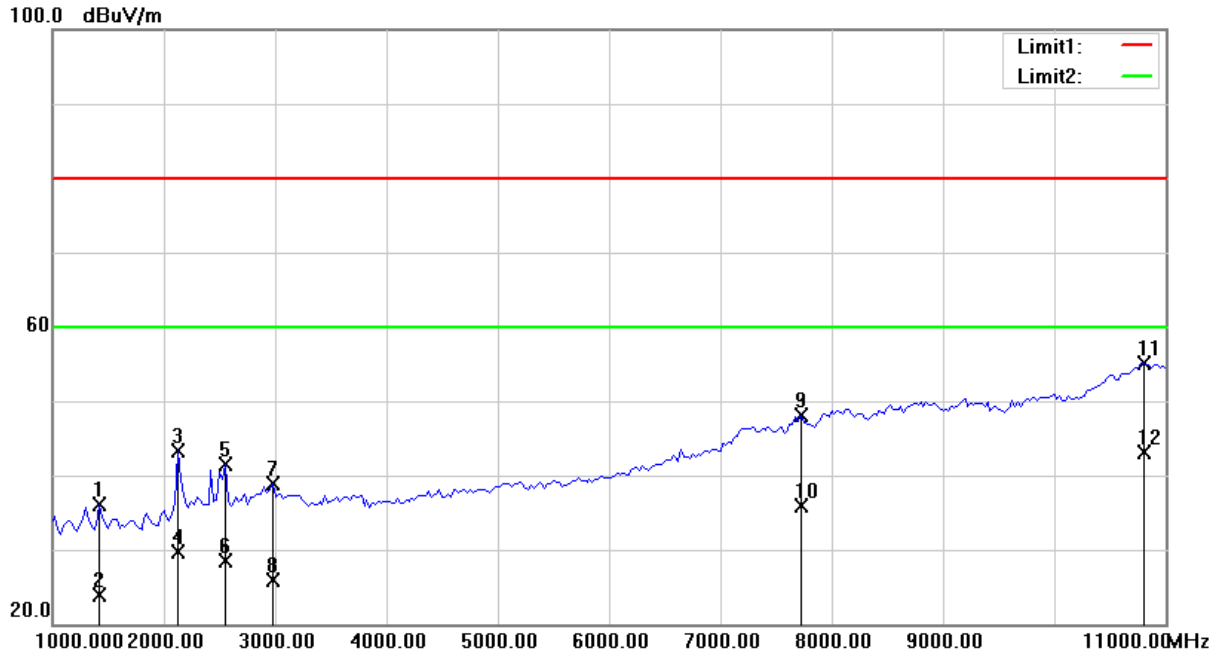

| No. | Frequency (MHz) | Reading Level (dBμV) | Correct Factor (dB/m) | Measurement (dBμV/m) | Limit (dBμV/m) | Margin (dB) | Table Degree (degree) | Antenna Height (cm) | Detector |
|-----|-----------------|----------------------|-----------------------|----------------------|----------------|-------------|-----------------------|---------------------|----------|
| 1   | 1425.000        | 48.21                | -12.05                | 36.16                | 80.00          | -43.84      | 11                    | 100                 | peak     |
| 2   | 1425.000        | 35.91                | -12.05                | 23.86                | 60.00          | -36.14      | 11                    | 100                 | AVG      |
| 3   | 2125.000        | 52.99                | -9.66                 | 43.33                | 80.00          | -36.67      | 154                   | 100                 | peak     |
| 4   | 2125.000        | 39.46                | -9.66                 | 29.80                | 60.00          | -30.20      | 154                   | 100                 | AVG      |
| 5   | 2550.000        | 50.32                | -8.85                 | 41.47                | 80.00          | -38.53      | 114                   | 200                 | peak     |
| 6   | 2550.000        | 37.33                | -8.85                 | 28.48                | 60.00          | -31.52      | 114                   | 200                 | AVG      |
| 7   | 2975.000        | 45.24                | -6.31                 | 38.93                | 80.00          | -41.07      | 158                   | 100                 | peak     |
| 8   | 2975.000        | 32.27                | -6.31                 | 25.96                | 60.00          | -34.04      | 158                   | 100                 | AVG      |
| 9   | 7725.000        | 41.50                | 6.53                  | 48.03                | 80.00          | -31.97      | 264                   | 200                 | peak     |
| 10  | 7725.000        | 29.35                | 6.53                  | 35.88                | 60.00          | -24.12      | 264                   | 200                 | AVG      |
| 11  | 10800.000       | 41.94                | 13.13                 | 55.07                | 80.00          | -24.93      | 201                   | 100                 | peak     |
| 12  | 10800.000       | 29.88                | 13.13                 | 43.01                | 60.00          | -16.99      | 201                   | 100                 | AVG      |

**Remark:** 1. peak = Peak, AVG = Average  
 2. Correction Factor = Antenna factor + Cable loss (Antenna to preamplifier) - preamplifier Gain + Cable loss (preamplifier to receiver)  
 3. Measurement Value = Reading Level + Correct Factor  
 4. Margin Level = Measurement Value - Limit Value



|                                 |              |                        |            |
|---------------------------------|--------------|------------------------|------------|
| <b>Test Voltage</b>             | 120Vac, 60Hz | <b>Frequency Range</b> | 1 – 11GHz  |
| <b>Environmental Conditions</b> | 23°C, 51% RH | <b>6dB Bandwidth</b>   | 1MHz       |
| <b>Test Date</b>                | 2024/02/26   | <b>Test Distance</b>   | 3m         |
| <b>Tested by</b>                | Karwin Kao   | <b>Polarization</b>    | Horizontal |
| <b>Test Site</b>                | W08-966-1    |                        |            |

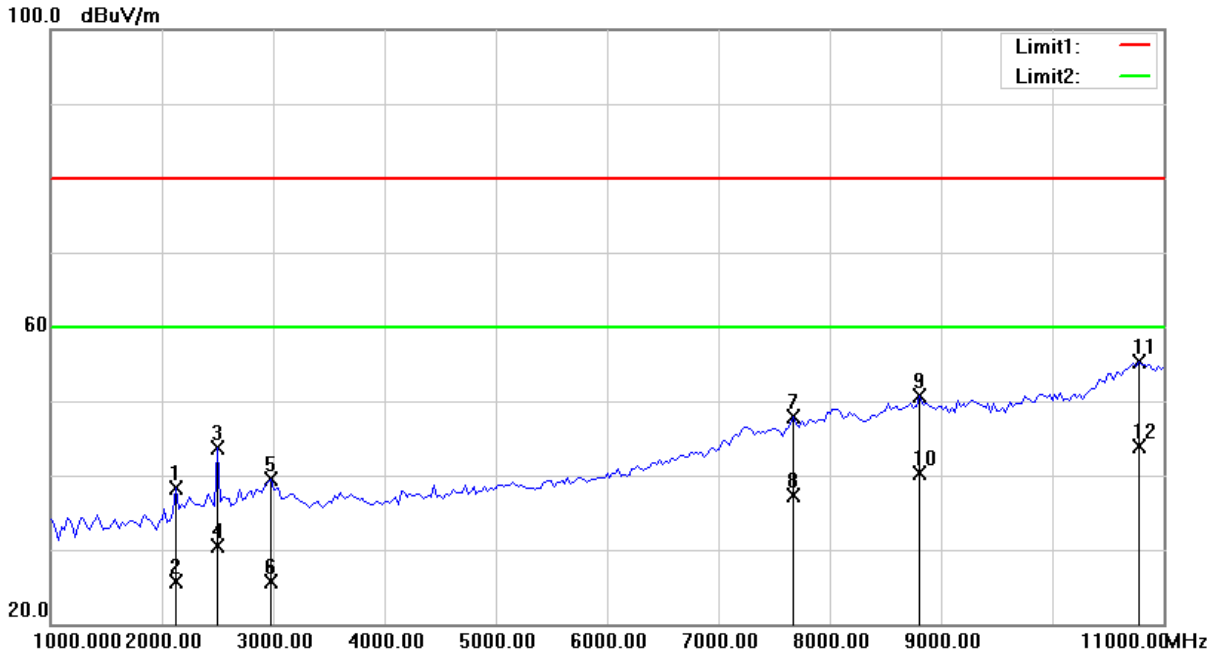

| No. | Frequency (MHz) | Reading Level (dBμV) | Correct Factor (dB/m) | Measurement (dBμV/m) | Limit (dBμV/m) | Margin (dB) | Table Degree (degree) | Antenna Height (cm) | Detector |
|-----|-----------------|----------------------|-----------------------|----------------------|----------------|-------------|-----------------------|---------------------|----------|
| 1   | 2125.000        | 48.05                | -9.66                 | 38.39                | 80.00          | -41.61      | 151                   | 200                 | peak     |
| 2   | 2125.000        | 35.45                | -9.66                 | 25.79                | 60.00          | -34.21      | 151                   | 200                 | AVG      |
| 3   | 2500.000        | 52.81                | -9.02                 | 43.79                | 80.00          | -36.21      | 342                   | 200                 | peak     |
| 4   | 2500.000        | 39.60                | -9.02                 | 30.58                | 60.00          | -29.42      | 342                   | 200                 | AVG      |
| 5   | 2975.000        | 45.86                | -6.31                 | 39.55                | 80.00          | -40.45      | 300                   | 100                 | peak     |
| 6   | 2975.000        | 32.06                | -6.31                 | 25.75                | 60.00          | -34.25      | 300                   | 100                 | AVG      |
| 7   | 7675.000        | 41.30                | 6.52                  | 47.82                | 80.00          | -32.18      | 67                    | 100                 | peak     |
| 8   | 7675.000        | 30.88                | 6.52                  | 37.40                | 60.00          | -22.60      | 67                    | 100                 | AVG      |
| 9   | 8800.000        | 40.98                | 9.68                  | 50.66                | 80.00          | -29.34      | 102                   | 100                 | peak     |
| 10  | 8800.000        | 30.59                | 9.68                  | 40.27                | 60.00          | -19.73      | 102                   | 100                 | AVG      |
| 11  | 10775.000       | 42.27                | 13.06                 | 55.33                | 80.00          | -24.67      | 187                   | 100                 | peak     |
| 12  | 10775.000       | 30.86                | 13.06                 | 43.92                | 60.00          | -16.08      | 187                   | 100                 | AVG      |

**Remark:** 1. peak = Peak, AVG = Average  
 2. Correction Factor = Antenna factor + Cable loss (Antenna to preamplifier) - preamplifier Gain + Cable loss (preamplifier to receiver)  
 3. Measurement Value = Reading Level + Correct Factor  
 4. Margin Level = Measurement Value - Limit Value

## 4.2.7 Photographs of Test Configuration

### Radiated Emission Test (30MHz~1GHz)



**Radiated Emission Test (Above 1GHz)**



< End Page >